

PERSONAL CONFIGURATION

created on 16.04.2024

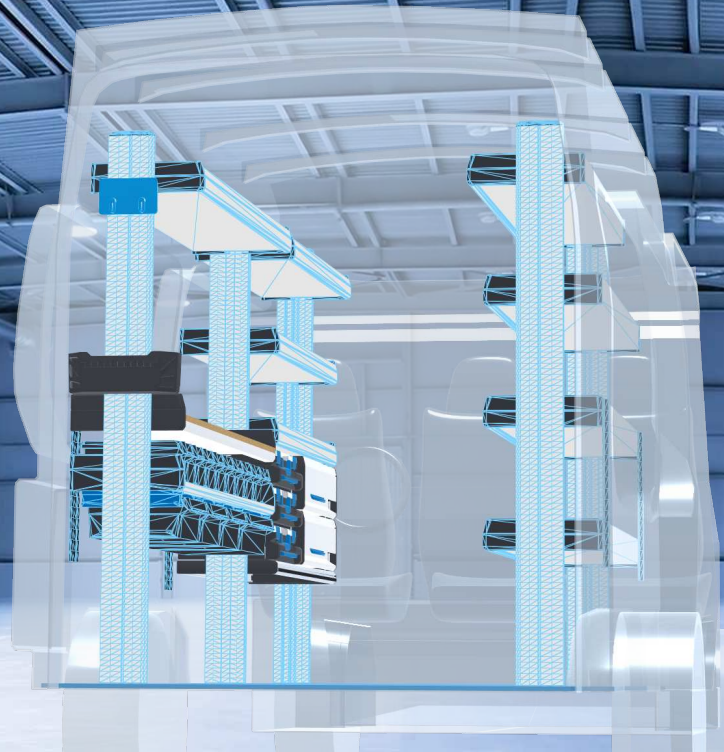

 Open plan in the online configurator

PLANNING DOCUMENT

Ford Transit 2014

Rear-wheel drive | right | Hinged door | L3 235" mm



Sortimo[®]

PERSONAL CONFIGURATION

created on 16.04.2024

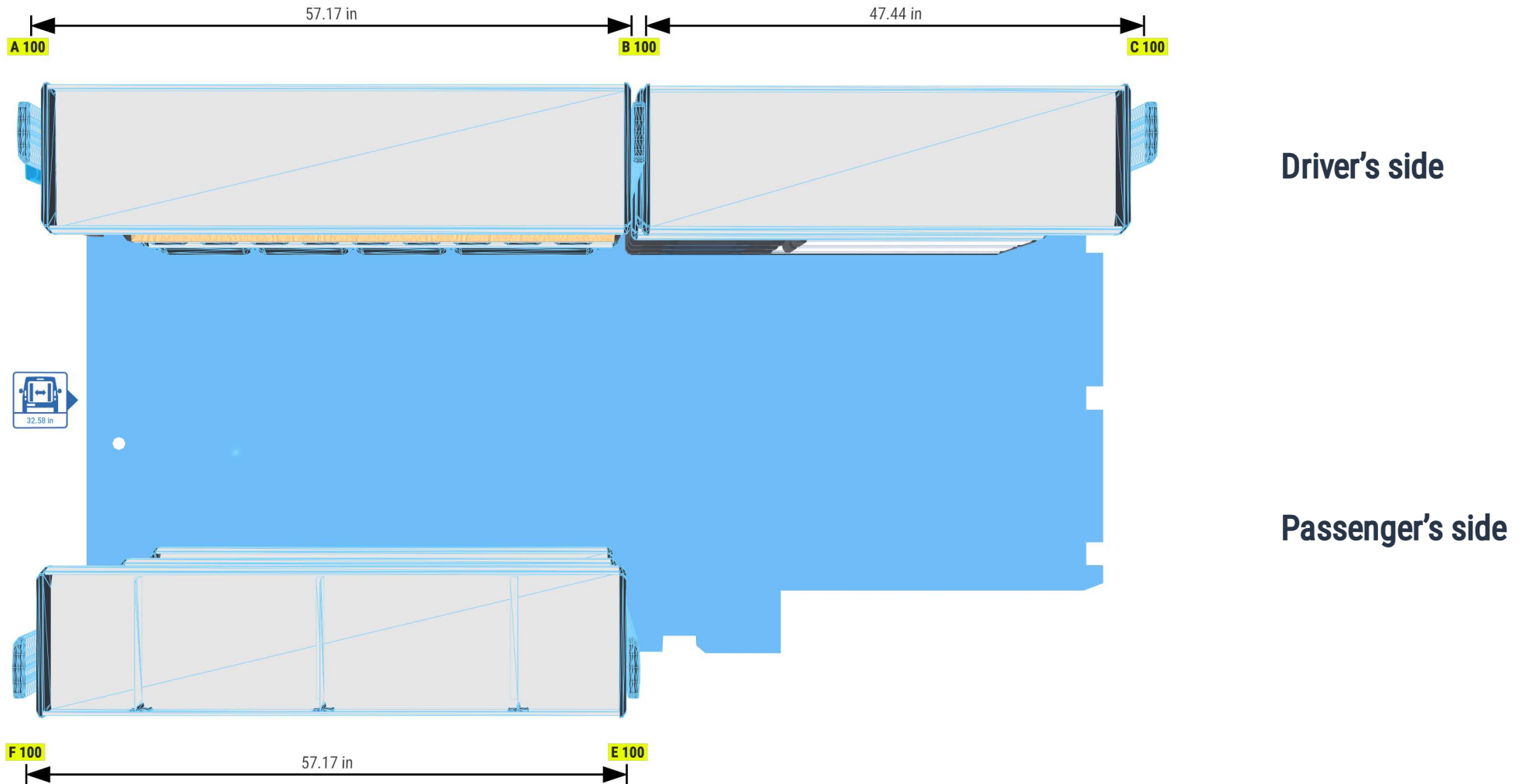

PERSONAL CONFIGURATION

created on 16.04.2024

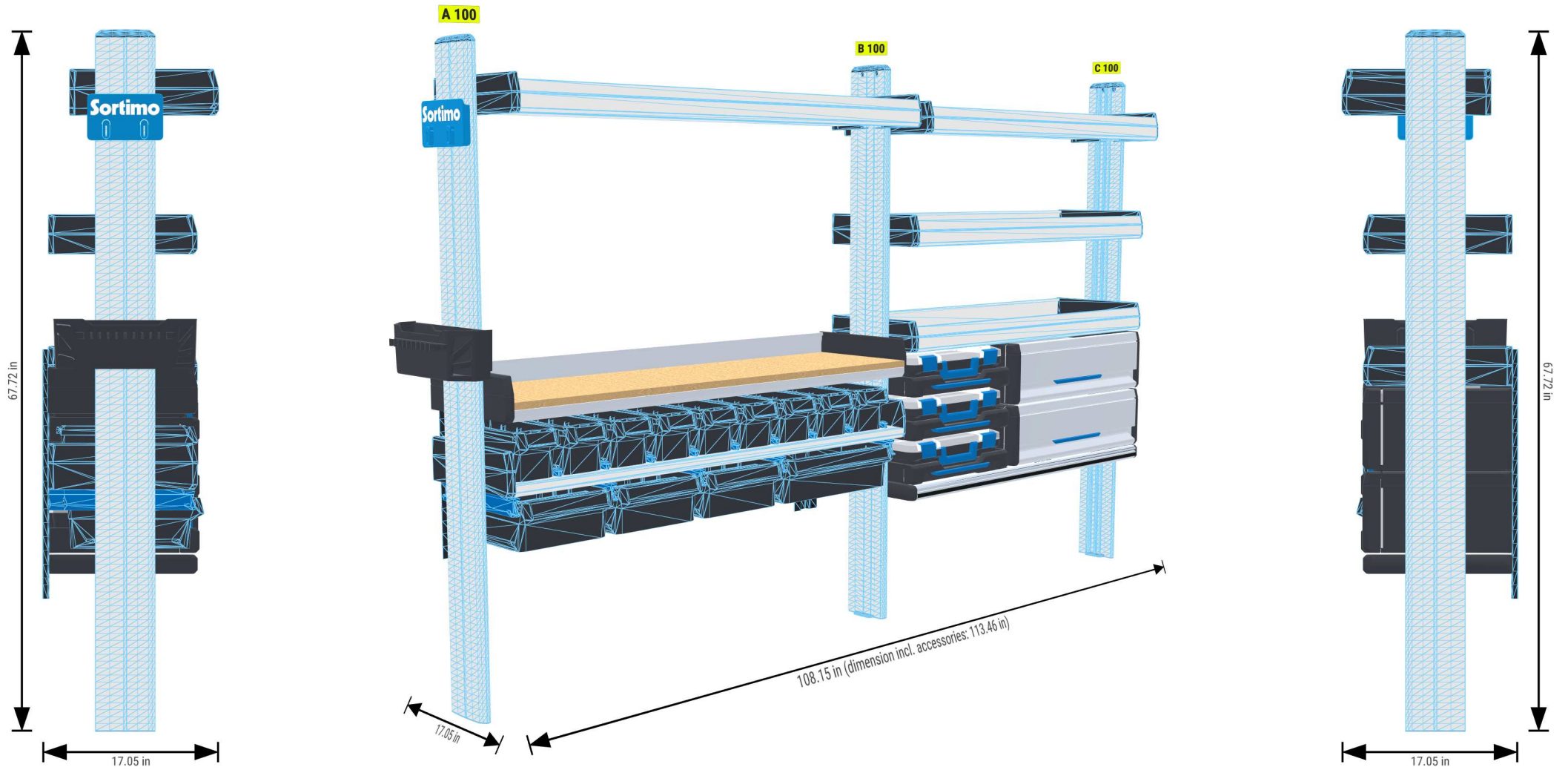

PERSONAL CONFIGURATION

created on 16.04.2024

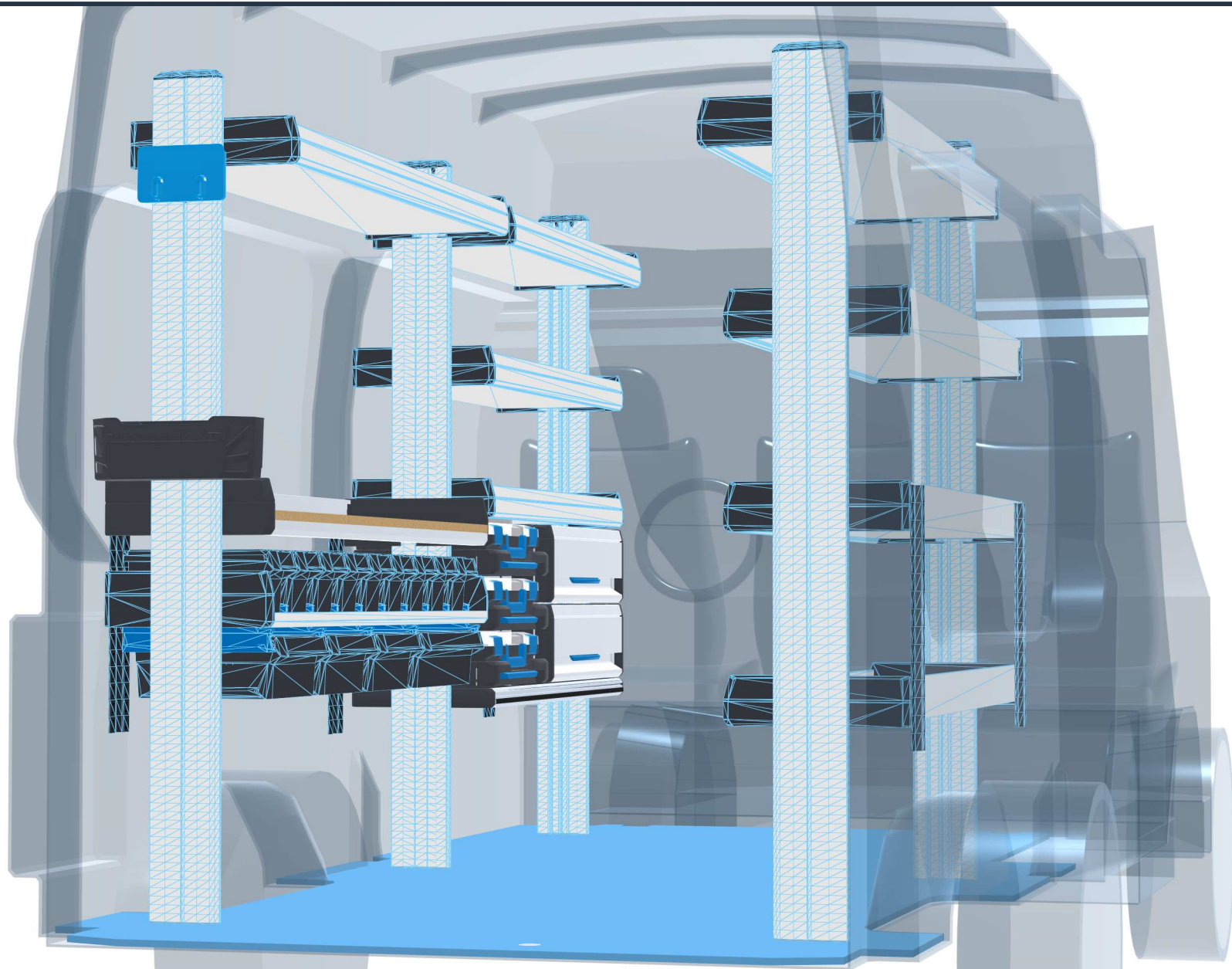

PERSONAL CONFIGURATION

created on 16.04.2024

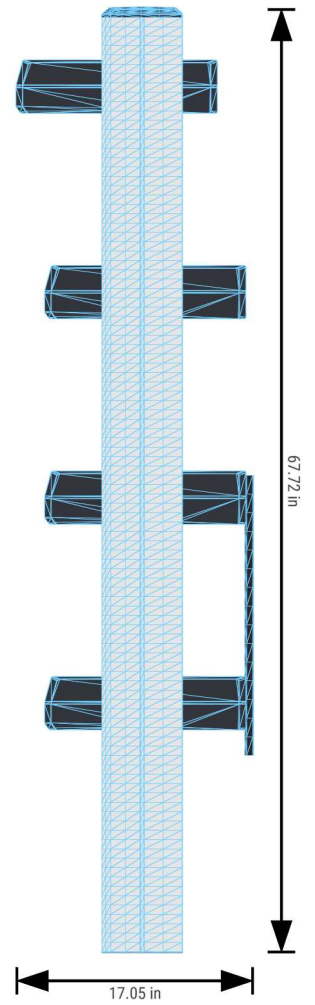
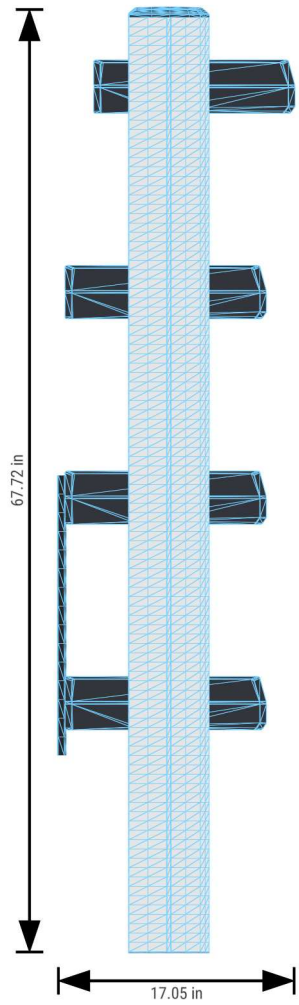

PERSONAL CONFIGURATION

created on 16.04.2024

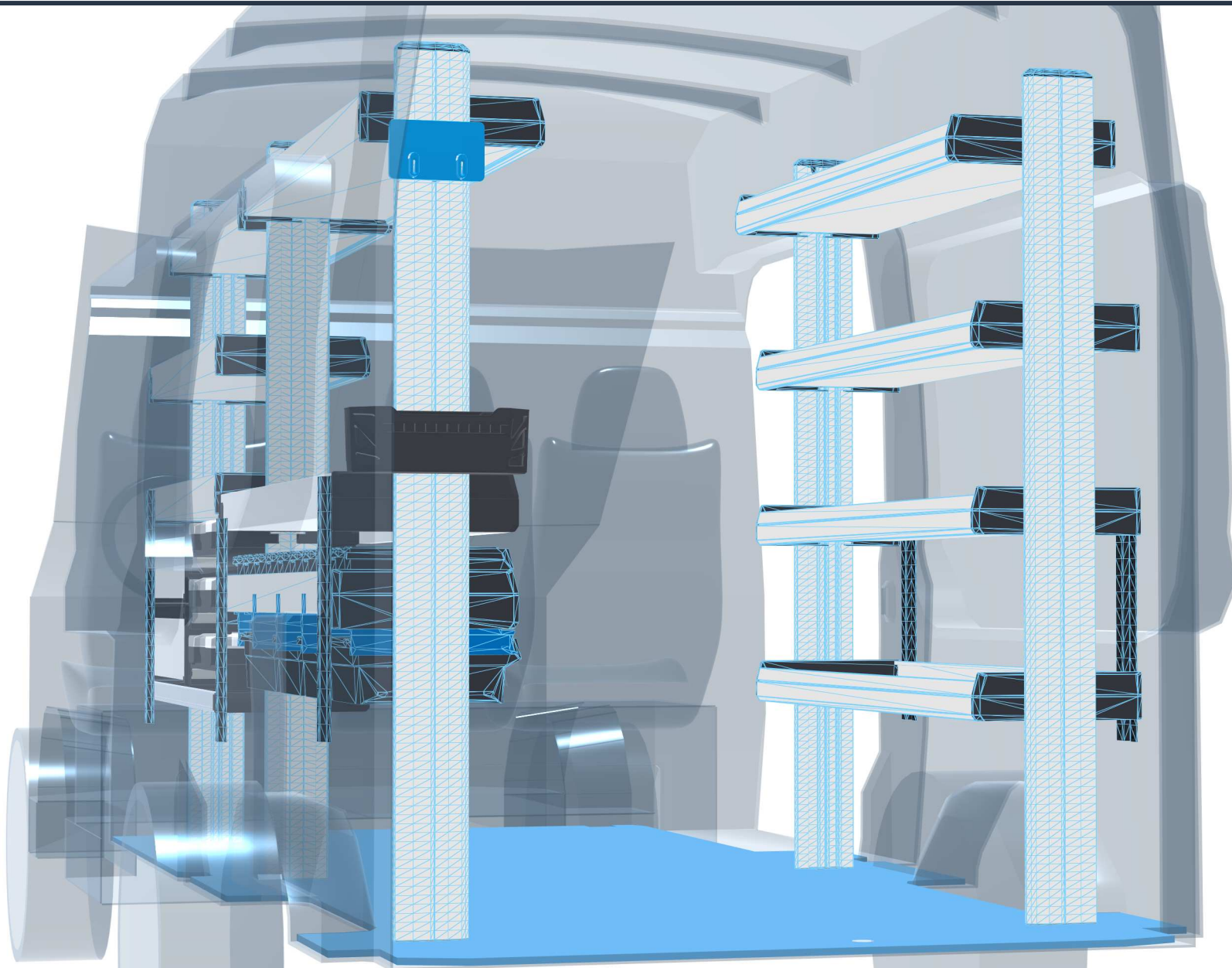

PERSONAL CONFIGURATION

created on 16.04.2024

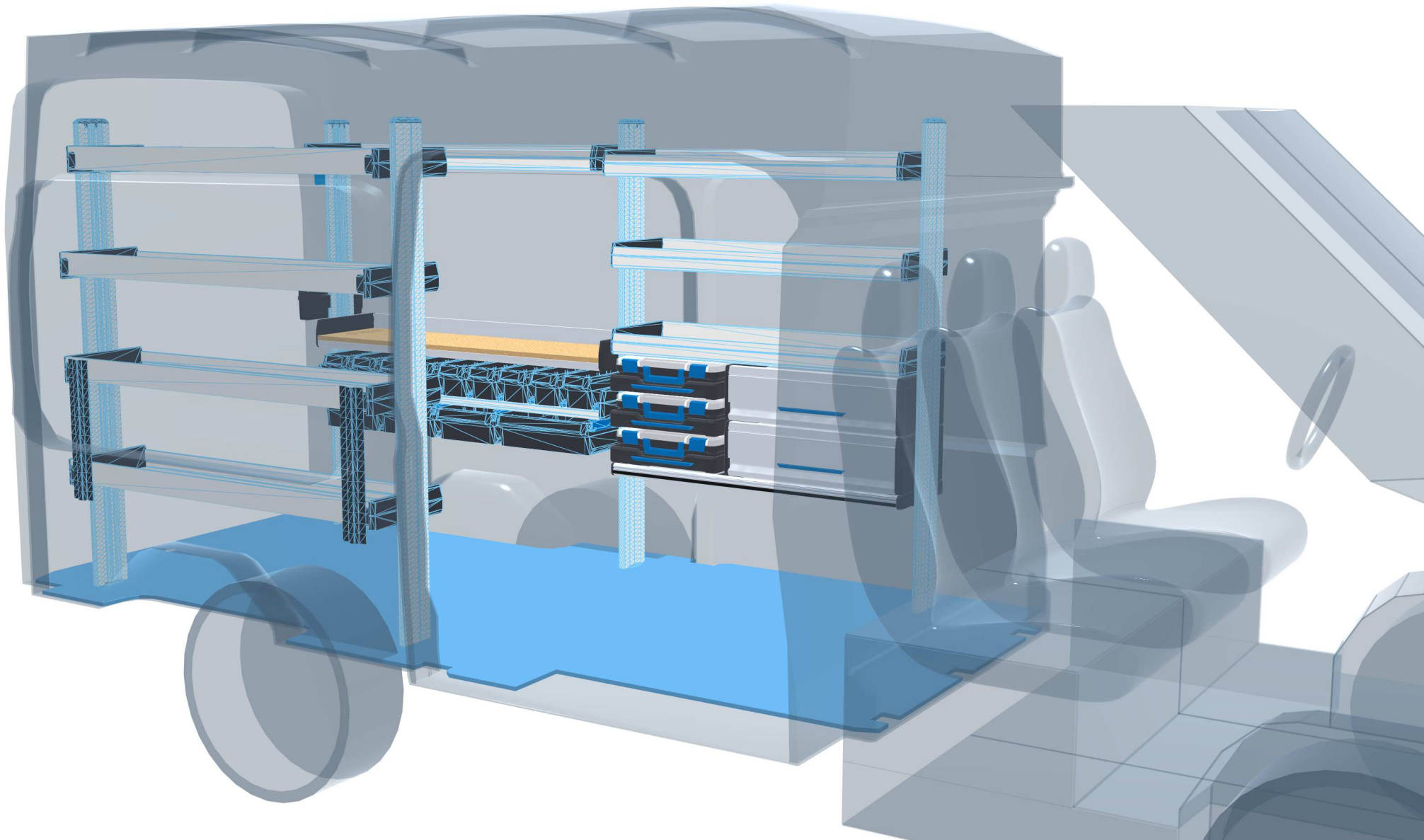

PERSONAL CONFIGURATION

created on 16.04.2024



Sortimo near you



Sign in



Shopping cart





[Products](#) | [Support](#) | [Company](#) | [Contact](#) | [Blog](#)

Home > Configurator

Eco





1
Cargo Space

2
Configuration

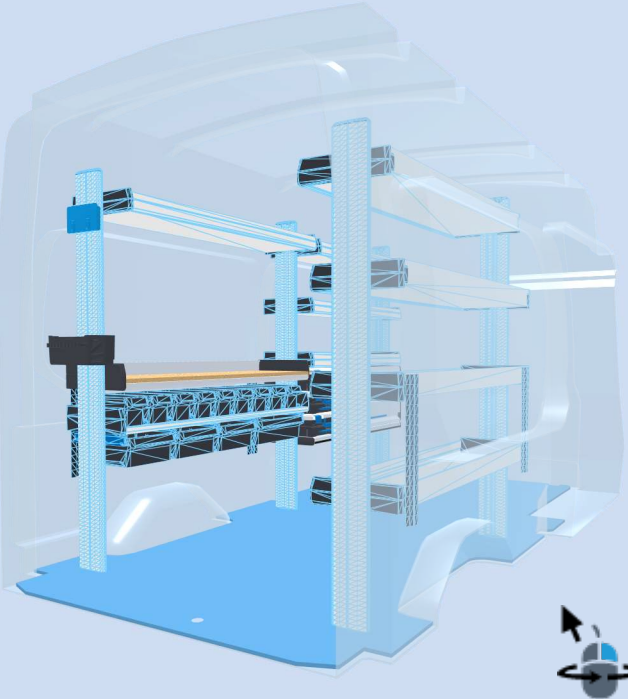
3
Accessories

4
Overview



Navigation icons:    



A list of all products, details and price information can be found in the quotation or the shopping basket.



Total weight:
106 lb



For questions, further enquiries, changes or orders, please contact your sales consultant or the Customer Service Center.

[Sortimo Contact >](#)

Sortimo®



Open plan in the online configurator

To ensure the configurator works properly, you should open it on your desktop PC or laptop and in Google Chrome, Safari or Firefox.