

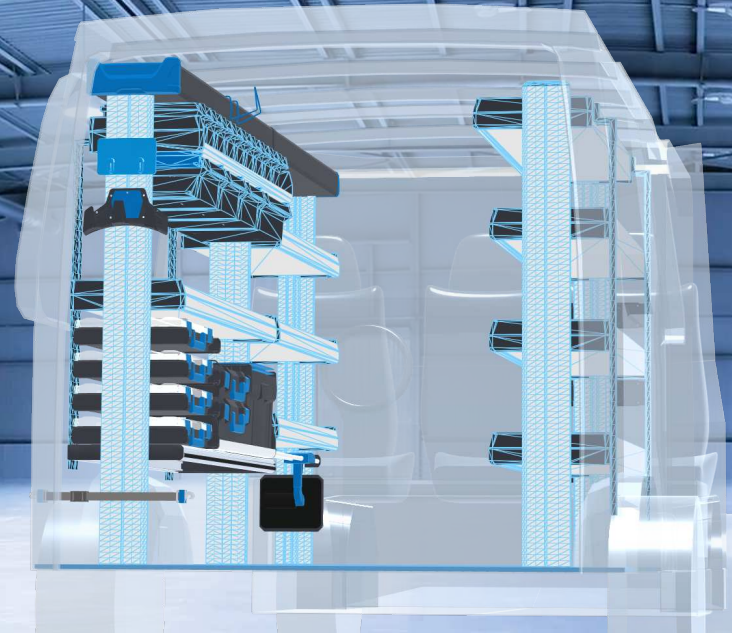

PERSONAL CONFIGURATION

created on 12.04.2024



 Open plan in the online configurator

PLANNING DOCUMENT

Mercedes-Benz Sprinter 2018 or later

Rear-wheel drive / four-wheel drive | right | Hinged door | Standard 234" mm



Sortimo[®]

PERSONAL CONFIGURATION

created on 12.04.2024

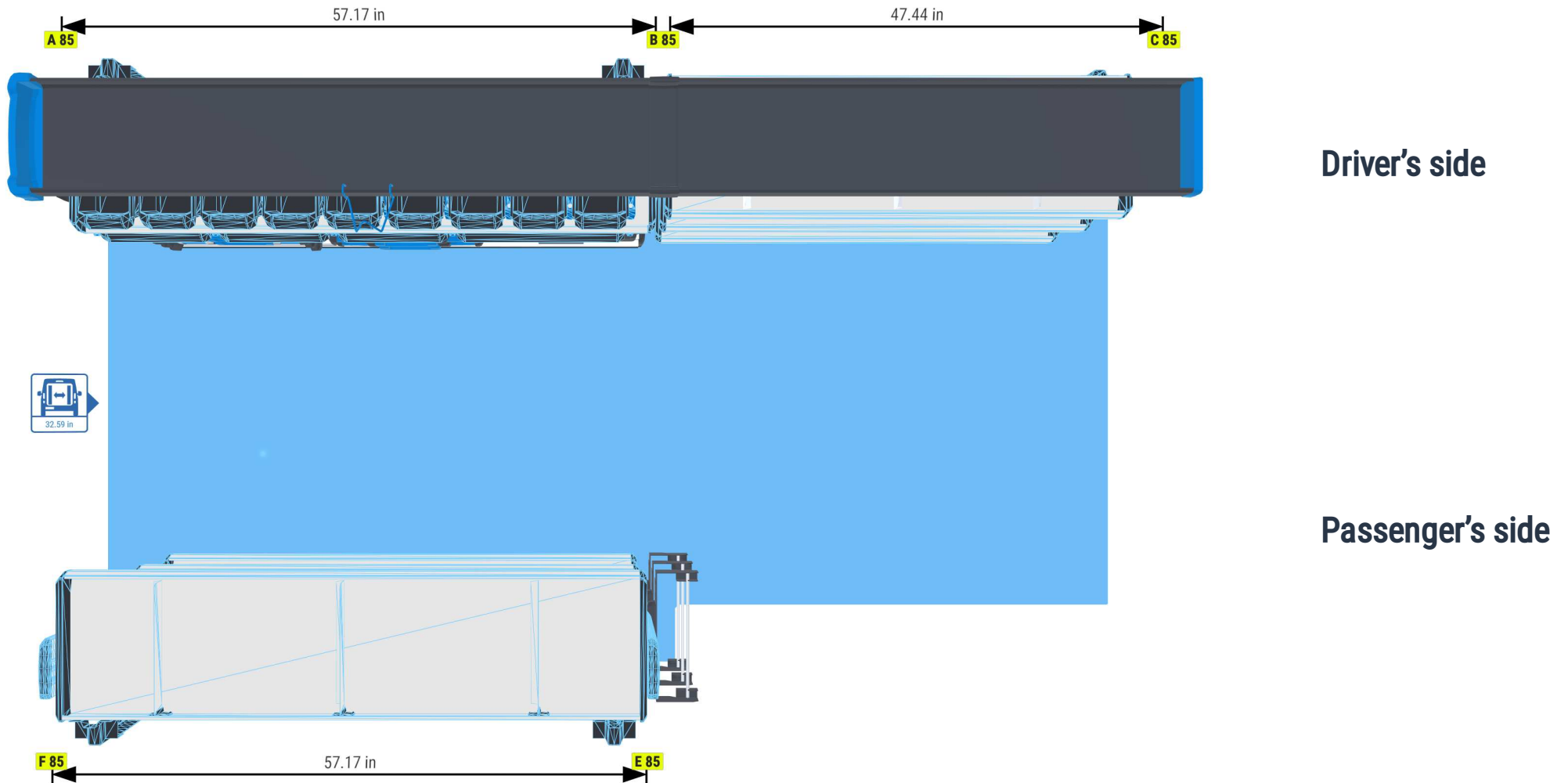

PERSONAL CONFIGURATION

created on 12.04.2024

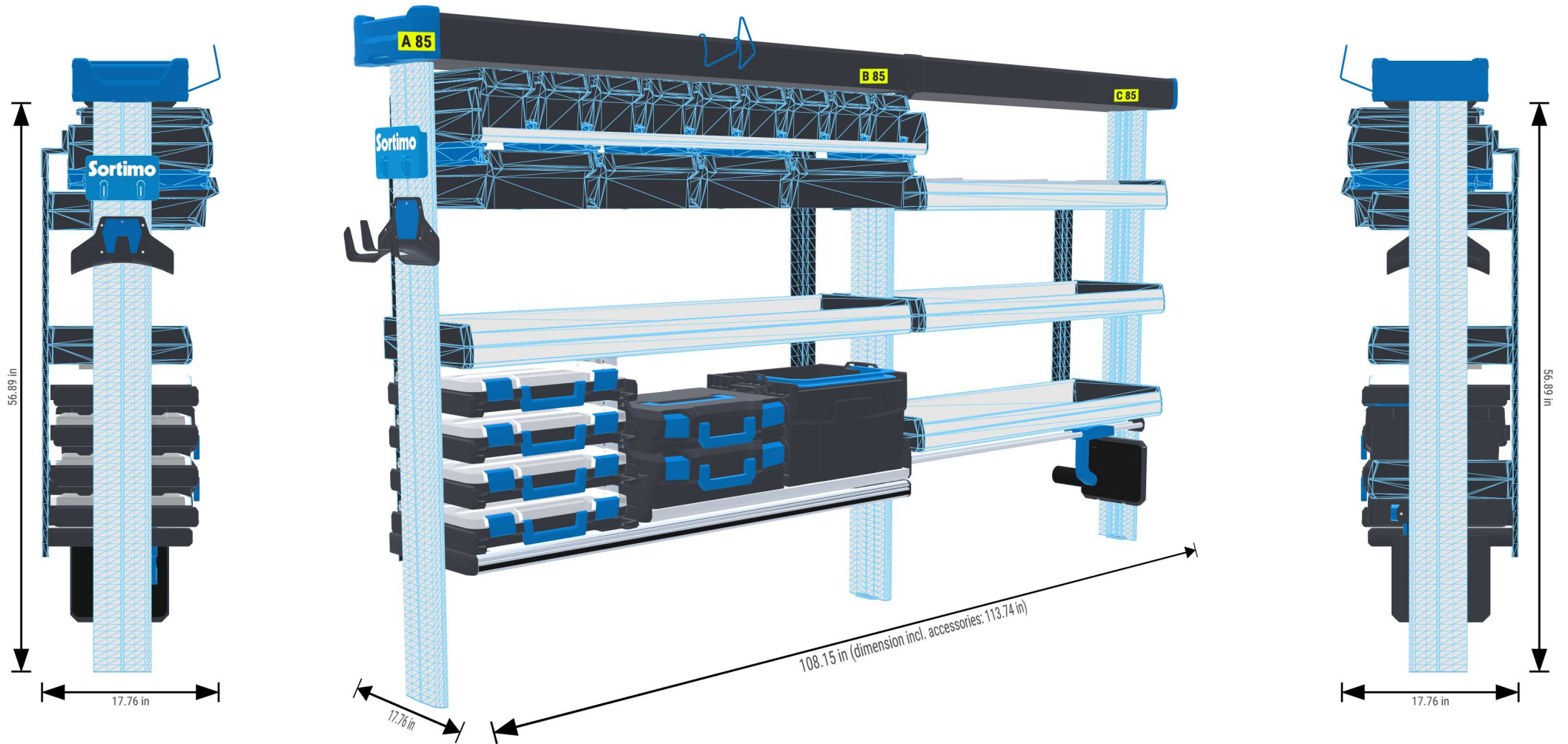

PERSONAL CONFIGURATION

created on 12.04.2024

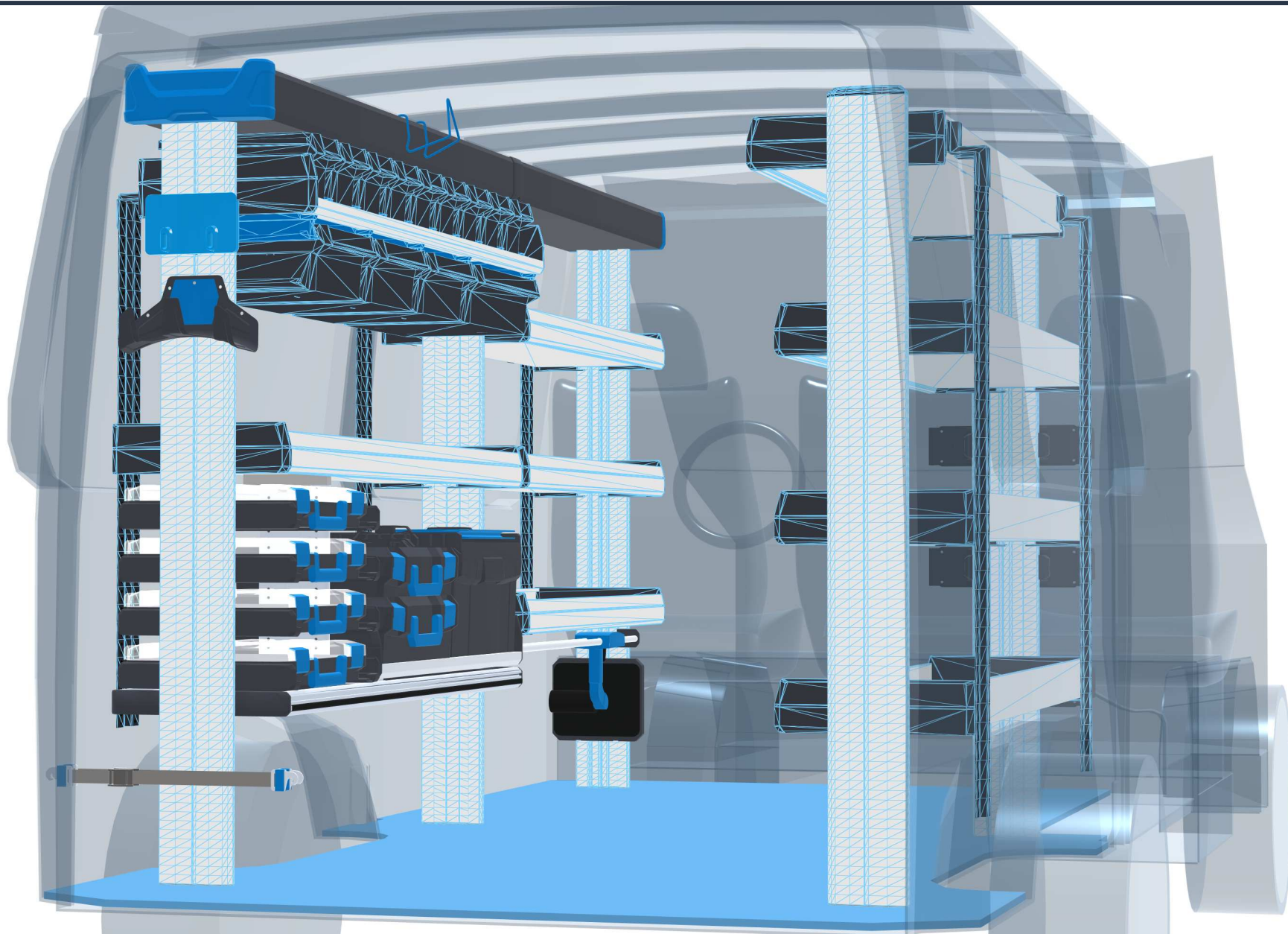

PERSONAL CONFIGURATION

created on 12.04.2024

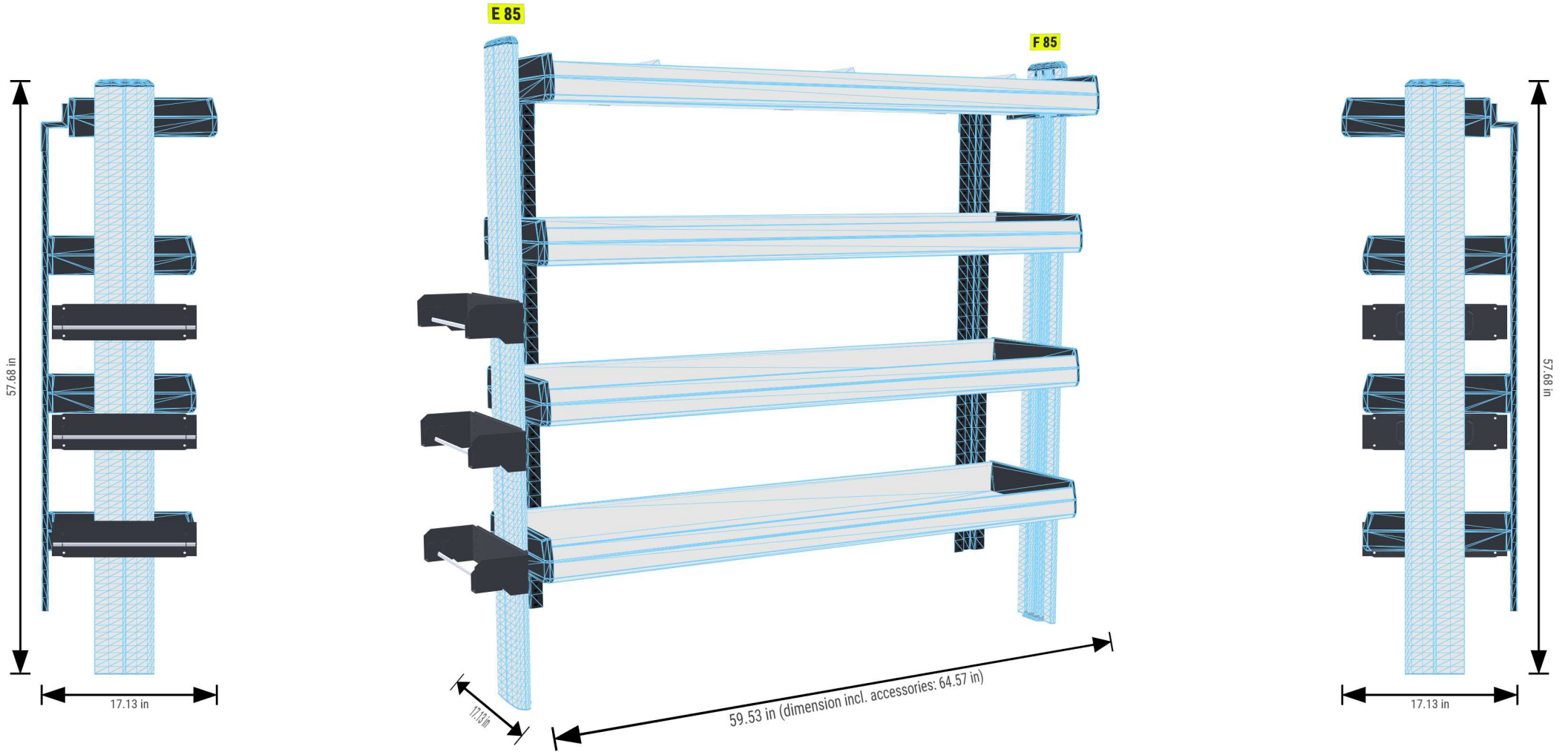

PERSONAL CONFIGURATION

created on 12.04.2024

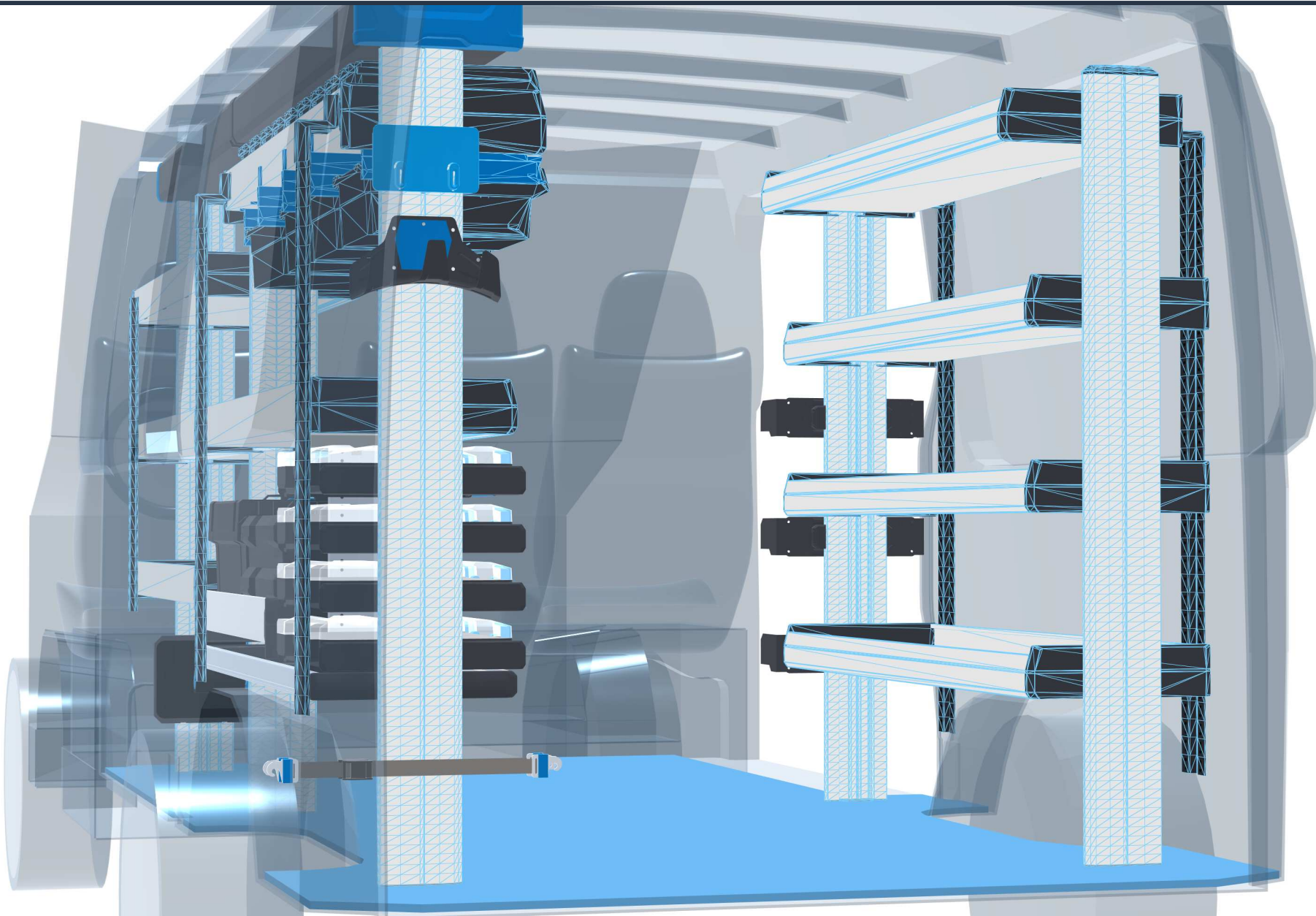

PERSONAL CONFIGURATION

created on 12.04.2024

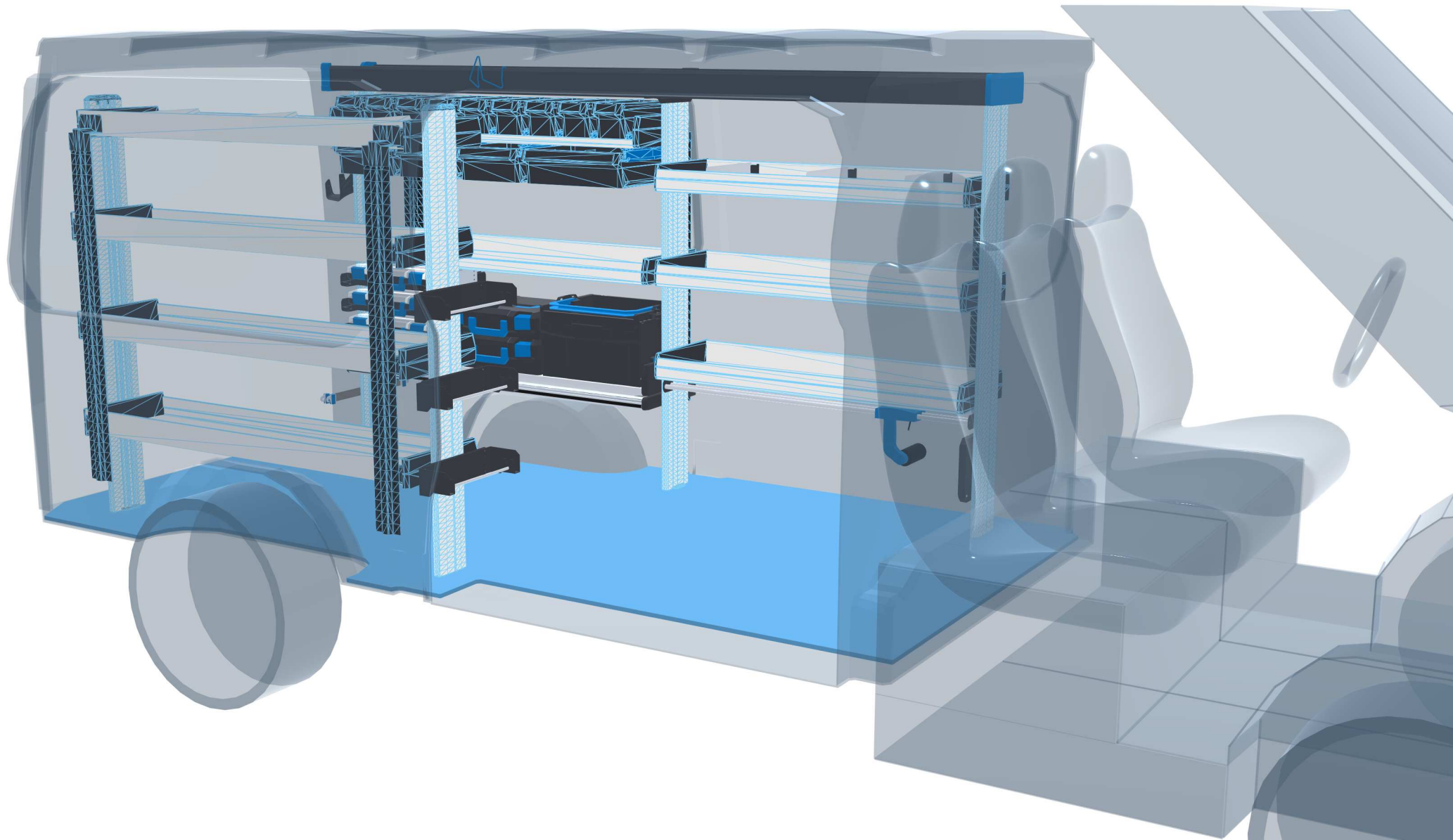

PERSONAL CONFIGURATION

created on 12.04.2024



Sortimo near you



Sign in







Shopping cart



[Products](#) | [Support](#) | [Company](#) | [Contact](#) | [Blog](#)

Home > Configurator

- Eco**
- 
1
Cargo Space
- 
2
Configuration
- 
3
Accessories
- 
4
Overview

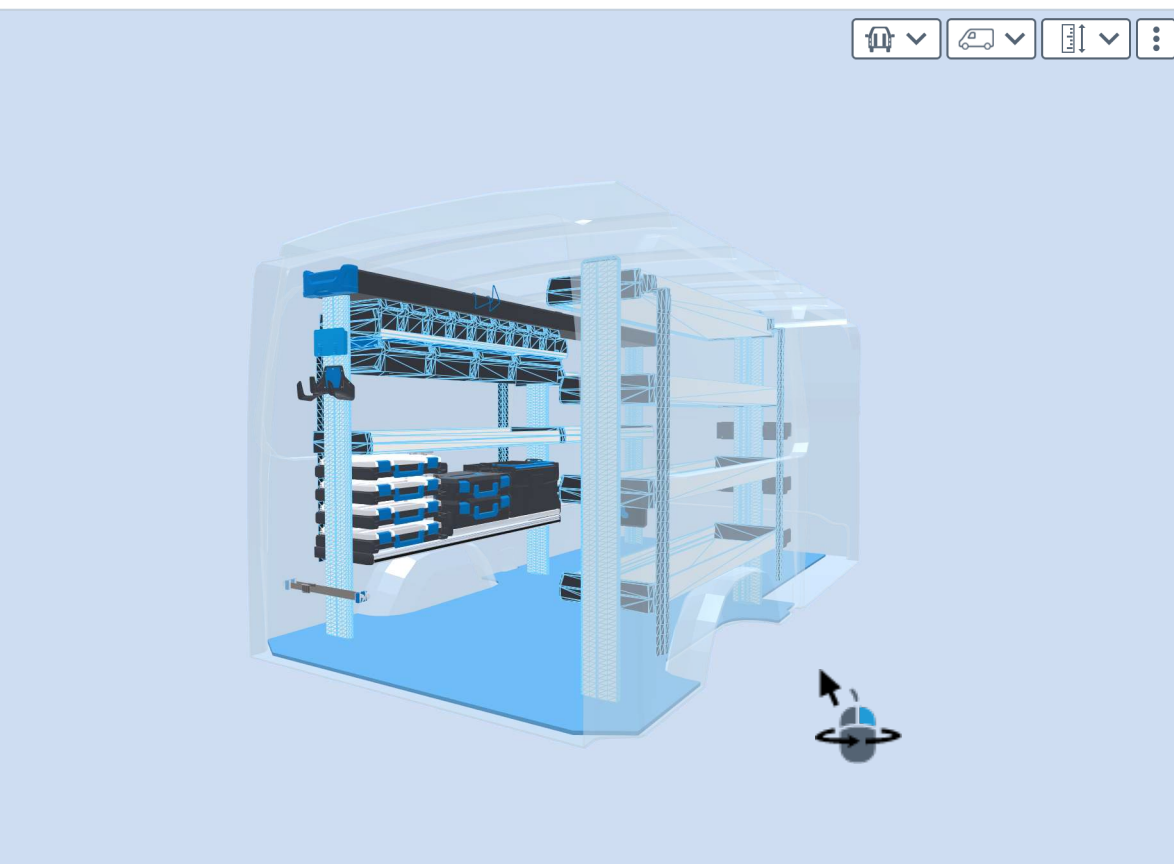

A list of all products, details and price information can be found in the quotation or the shopping basket.



Total weight:
93 lb



For questions, further enquiries, changes or orders, please contact your sales consultant or the Customer Service Center.

[Sortimo Contact >](#)



Open plan in the online configurator

To ensure the configurator works properly, you should open it on your desktop PC or laptop and in Google Chrome, Safari or Firefox.